

**UNIFORM STATUTORY DECLARATION FORM FOR THE REGISTRATION OF FITTING DESIGNS**

NEW BRUNSWICK  
NUNAVUT

NOVA SCOTIA  
YUKON

PRINCE EDWARD ISLAND  
NORTHWEST TERRITORIES

NEWFOUNDLAND AND LABRADOR

MANUFACTURERS NAME: <u>Swagelok Company</u>	
MANUFACTURERS ADDRESS: <u>29500 Solon Road, Solon, Ohio 44139 USA</u>	
PLANT LOCATIONS: <u>Headquarters: 29500 Solon Road, Solon, Ohio 44139 USA (See Attachment A)</u>	
<p><b>CATEGORY OF FITTINGS TO BE REGISTERED. CIRCLE ONE CATEGORY ONLY</b></p> <p><input checked="" type="radio"/> A Pipe fittings, including couplings, tees, elbows, Ys, plugs, unions, pipe caps, or reducers</p> <p><input type="radio"/> B Flanges: all flanges</p> <p><input type="radio"/> C Valves: all line valves</p> <p><input type="radio"/> D Expansion joints, flexible connections, and hose assemblies: all types</p> <p><input type="radio"/> E Strainers, filters, separators, and steam traps</p> <p><input type="radio"/> F Measuring devices, including pressure gauges, level gauges, sight glasses, levels, or pressure transmitters</p> <p><input type="radio"/> G Certified capacity-rated pressure relief devices acceptable as primary over pressure protection on boilers, pressure vessels, piping and fusible plugs</p> <p><input type="radio"/> H Pressure retaining components that do not fall into one of the above categories</p> <p><input type="radio"/> N Nuclear components: Class 1 <input type="checkbox"/> Class 2 <input type="checkbox"/> Class 3 <input type="checkbox"/>. (Meeting AECB or ASME requirements)</p>	<p><b>TITLE OF THE STANDARD OF CONSTRUCTION</b></p> <p>ASME B31.1 for unlisted components, ASME B31.3 for unlisted components</p>
SHOW MANUFACTURERS NAME, TRADEMARK, OR LOGO AS IT WILL APPEAR ON THE PRODUCT	
Swagelok	<p><b>TYPE OF CONSTRUCTION</b></p> <p>FORGED <input type="checkbox"/> WELDED <input type="checkbox"/> WROUGHT <input checked="" type="checkbox"/></p> <p>CAST <input type="checkbox"/> OTHER <input type="checkbox"/></p> <p>DESCRIBE OTHER:</p>
<p><b>LIST OF SUPPORTING DOCUMENTATION AND IDENTIFICATION OF THE ACTUAL ITEMS TO BE REGISTERED:</b></p> <p>ISO 9001:2015 Certificate, Attachment A, Attachment B, Catalog Information and other Support Documents</p>	

**DECLARATION:**

I, Joel Feldman, Vice President, Engineering (see note 3) employed by Swagelok Company and being the person having full authority and responsibility for the quality of the end product do solemnly declare that the information contained in this form is true and to the best of my knowledge represents the product for which registration is sought. The dimensions, materials of construction, pressure temperature ratings, and identification markings are in accordance with the herein named standards. I further declare that the manufacture of these fittings is regulated by a Quality Control Program which extends to each plant where fabrication occurs in whole or in part and has been verified by BSI as being suitable for that purpose and I make this solemn declaration conscientiously believing it to be true, and knowing that it is of the same force and effect as if made under oath.

Signature of Declarer: [Signature]

Declared before me at Solon, Ohio

This 10<sup>th</sup> day of June AD 2019

Commissioner of Oaths or Notary Public: (sign) [Signature]

(Affix Official seal to the right)

USE THIS SPACE FOR OFFICIAL



This space for Regulatory Authority use	
This registration must be revalidated after ten (10) years from the date of acceptance	
CRN: <u>0A21839.5</u>	Newfoundland Labrador Service NL Registered <u>0A21839.50</u> Date <u>19/11/15</u> Engineering and Inspection Services Registered by <u>[Signature]</u> UNDER THE AUTHORITY OF THE PUBLIC SAFETY ACT AND THE BOILER, PRESSURE VESSEL AND COMPRESSED GAS REGULATIONS
FID#: <u>1214</u>	
<p><b>VCR METAL GASKET FACE SEAL FITTINGS</b></p> <p>Notes:</p> <ol style="list-style-type: none"> <li>All fittings shall be registered in the name of the Manufacturer.</li> <li>Each category shall be supported with two Statutory Declaration forms and one copy of supporting documentation.</li> <li>The declaration shall be made by the person having full authority and responsibility for the quality of the end product.</li> <li>Quality control programs shall be resubmitted for validation at a maximum interval of five (5) years.</li> </ol> <p><b>CRN EXPIRES OCT. 4, 2029 - D.G.</b></p>	



**Attachment B: Scope of CRN Registration for Swagelok® VCR® and High Flow VCR Metal Gasket Face Seal Fittings (Category A)**

This document presents the scope of Swagelok® VCR® and High Flow VCR (HVCR) Metal Gasket Face Seal Fittings covered by this submission for CRN registration. These fittings were designed and evaluated in accordance with ASME B31.1-2016 "Power Piping" for unlisted components and ASME B31.3-2016 "Process Piping" for unlisted components. *OA 21889.5*

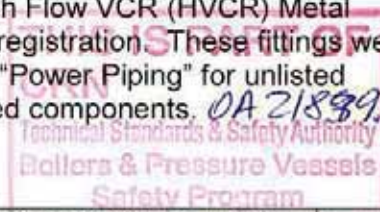

**Summary Table**

Product Series (Size)	Pressure Retaining Materials	Pressure Retaining Components	End Connections and Sizes	Maximum Rated Pressure <sup>1</sup>		Design Code of Construction
				At 100°F	At Max Temp (1000°F unless noted otherwise)	
-1 VCR <sup>2</sup> (1/16")	316 SS (ASTM A479)	Gland	Tube Socket Weld 1/16"	9000 psig	5080 psig	ASME B31.1 (Unlisted Components) and ASME B31.3 (Unlisted Components)
-2 VCR (1/8")	316 SS (ASTM A479) for straight fittings F316 SS (ASTM A182) for shaped fittings	Gland, Body	Tube Socket Weld 1/8"	7100 psig	4010 psig	
			Male Tube Weld 1/16"-1/8"	11,200-8500 psig	6320-4800 psig	
			Tube Butt Weld 1/8"	8500 psig	3740 psig	
			Male NPT 1/16" – 1/8"	9000 psig	6210 psig @ 450°F w/sealant	
			Female NPT 1/16" – 1/8"	6700-6500 psig	4620-4480 psig @ 450°F w/sealant	
-4 VCR (1/4")	316 SS (ASTM A479) for straight fittings F316 SS (ASTM A182) for shaped fittings	Gland, Body	Tube Butt Weld 1/4", 6mm	6800-5100 psig	2990-2240 psig	
			Automatic Tube Weld 1/4", 6-8mm			
			Tube Socket Weld 1/4"	5500 psig	3100 psig	
			Reducing Tube Socket Weld 1/8"	8000 psig	4520 psig	
			Male Tube Weld 1/8"-1/4"	10,000 psig	5650 psig	
			Male NPT 1/8"-1/4"	10,000 psig	6900 psig @ 450°F w/sealant	
			Male SAE/MS 9/16-18	4500 psig	4500 psig @ 400°F	
	Female NPT 1/8"-1/4"	8000-6600 psig	5520-4550 psig @ 450°F w/sealant			
	17-4 PH Metal Injection Mold (MPIF Std 35)	Split Nuts	Nuts Only	5100 psig	3130 psig @ 650°F	
-4 HVCR (1/4")	316 SS (ASTM A479) for straight fittings F316 SS (ASTM A182) for shaped fittings	Gland, Body	Bodies only	10,000 psig	5650 psig	
			Tube Butt Weld 3/8" Automatic Tube Weld 3/8"	3300 psig	1450 psig	

Notes:

1. Above maximum rated pressures are for fittings with 316L SS Gasket
2. -1 VCR uses -2 VCR size nut and gasket.

**Summary Table (cont'd)**

Product Series (Size)	Pressure Retaining Materials	Pressure Retaining Components	End Connections and Sizes	Maximum Rated Pressure <sup>1</sup>		Design Code of Construction
				At 100°F	At Max Temp (1000°F unless noted otherwise)	
-6 VCR (3/8")  -8 VCR (1/2")		Gland, Body	Tube Butt Weld 1/4", 3/8", 1/2", 8mm, 10mm, 12mm Automatic Tube Weld 3/8, 1/2", 10mm, 12mm	3500-3100 psig	1540-1360 psig	ASME B31.1 (Unlisted Components)  and  ASME B31.3 (Unlisted Components)
			Tube Socket Weld 3/8", 1/2"	4300-3000 psig	2430-1690 psig	
			Reducing Tube Socket Weld 1/4"	3500 psig	1970 psig	
			Male Tube Weld 1/4", 3/8", 1/2"	4300-3500 psig	2430-1970 psig	
			Male NPT 1/4", 3/8", 1/2" Female NPT 3/8", 1/2"	4300 psig	2960 psig @ 450°F w/sealant	
			Male SAE/MS 7/8-14, 9/16-18	3500 psig	3070 psig@400°F	
			Tube Fitting 1/8", 1/4", 3/8", 1/2", 3/4", 4mm, 6mm, 8mm, 10mm, 12mm, 18mm	4300 psig	2430 psig	
-10 VCR (5/8")	316 SS (ASTM A479) for straight fittings	Gland, Body	Tube Butt Weld 5/8"	2800 psig	1230 psig	
			Tube Socket Weld 5/8"	2800 psig	1410 psig	
			Male Tube Weld 5/8"	2800 psig	1580 psig	
-12 VCR (3/4")	F316 SS (ASTM A182) for shaped fittings	Gland, Body	Tube Butt Weld 3/4", 18mm Automatic Tube Weld 3/4", 18mm	3000-2400 psig	1320-1050 psig	
			Tube Socket Weld 3/4"			
			Tube Fitting 1/8", 1/4", 3/8", 1/2", 3/4", 1", 6mm, 12mm, 18mm	2800 psig	1580 psig	
			Male Tube Weld 3/4"	3700 psig	2090 psig	
			Male NPT 3/4" Female NPT 3/4"	3700 psig	2550 psig @ 450°F w/sealant	
-16 VCR (1")		Gland, Body	Tube Butt Weld 1" Automatic Tube Weld 1"	2400 psig	1050 psig	
			Tube Socket Weld 1" Male Tube Weld 1"	3000 psig	1690 psig	
			Male NPT 1" Female NPT 1"	3000 psig	2070 psig @ 450°F w/sealant	
			Tube Fitting 1/4", 1/2", 1"	3000 psig	1690 psig	

Note 1. Above maximum rated pressures are for fittings with 316L SS Gasket



## Product Description

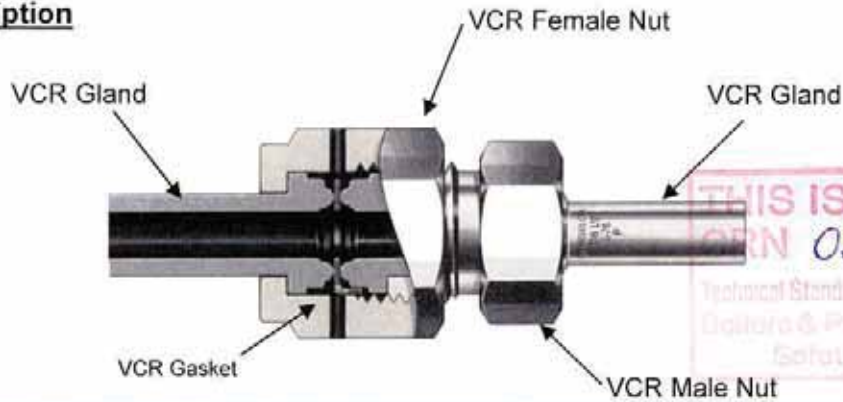

THIS IS PART OF  
 CORN 0A21839.5  
 Technical Standards & Safety Authority  
 Ductile & Pressure Vessels  
 Safety Program

## Typical VCR Assemblies

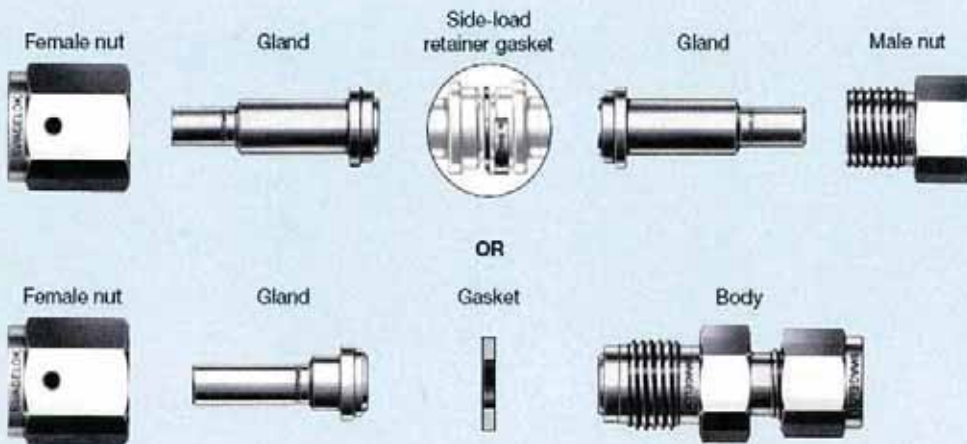







- o High Flow VCR (HVCR) is only offered in the 1/4 in. size. The only difference from the 1/4 in. VCR is a larger inside diameter.

## Configurations







VCR/HVCR Glands	
VCR/HVCR Male Bodies	
VCR/HVCR Shapes (Elbows, Tees, and Crosses)	
VCR Female Bodies	
VCR Split Nuts	 Female      Male

**Gland end connections**

Part Description	Sizes
Long Tube Butt Weld Short Tube Butt Weld	 1/16 in. - 1 in.
Short Automatic Tube Butt Weld Long Automatic Tube Butt Weld	 1/4 in. - 1 in.
Socket Weld Short Socket Weld	 1/8 in. - 1 in.
Reducing Socket Weld	 1/8 in. and 1/4 in.
Male Tube Weld	 1/8 in. - 1 in.
Tube Adapter	 1/8 in. to 1 in.
High-Flow VCR Gland End	 3/8 in. Tube Butt Weld

THIS IS PART OF  
 CRN *QA21839.5*  
 Technical Standards & Safety Authority  
 Boilers & Pressure Vessels  
 Safety Program

## Body Types

Part Description	Sizes
Tube Fitting	 1/16 in – 1 in
Tube Fitting Bulkhead Connector	 1/8 in – 16MM
Female NPT	 1/16 in – 1 in.
Male NPT	 1/16 in. – 1 in.
Male NPT Bulkhead	 1/4 in.
Straight Thread O-ring Seal Male Connector	 9/16-18, 7/8-14
Tube Butt Weld Bulkhead Connector	 1/4 in.

THIS IS PART OF  
 CRN 0A 21839.5  
 Technical Standards & Safety Authority  
 Gullers & Pressure Vessels  
 Safety Program

## Product Options:

Some of the product options listed below affect the pressure-temperature ratings shown in the Summary Table above, but in all cases the ratings are less than those shown in the above table.

- Gasket Options
  - Nickel
  - Copper
  - Teflon
  - Blind Gaskets
  - Snubber Gaskets
  
- Pressure Bearing Component Material Options (allowable variations of 316 material) that may affect high temperature rating
  - 316L
  - 316LV (VAR)
  - 316LVV (VIMVAR)

Additional options and non-pressure boundary alterations that do not affect pressure-temperature ratings may be made available within the scope of this approval. Examples of these options are:

- Protective Caps
- Gasket Retainer Assemblies
- Caps and Plugs with Lanyards
- Flow Restrictors
- Fitting and Valve Locking Devices
- Side Load Installation Tool and Tray
- "Bore-through" fitting through holes

## Quality System

The Swagelok Company quality system complies with the requirements of ISO 9001:2015. Swagelok Company maintains BSI Certificate of Registration Number FM 01729, which applies to all locations listed on the Certificate.

## References

The product catalog does not represent the full scope of the registration but rather details some of the most common options:

- VCR Metal Gasket Face Seal Fittings Product Catalog MS-01-24, Rev. Q



**Attachment A. Swagelok Manufacturing Locations**

This document lists the Swagelok locations where end item or component level manufacturing activities take place.

Swagelok Company 29500 Solon Road Solon, Ohio 44139 USA	Swagelok Company (Falon 1) 348 Bishop Road Highland Heights, Ohio 44143 USA
Swagelok Company (Highland) 318 Bishop Road Highland Heights, Ohio 44143 USA	Swagelok Company (Falon 2) 358 Bishop Road Highland Heights, Ohio 44143 USA
Swagelok Company (OFC) 29495 F.A. Lennon Drive Solon, Ohio 44139 USA	Swagelok Company (HPF) 6050 Cochran Road Solon, Ohio 44139 USA
Swagelok Company (Atlantic) 26651 Curtiss Wright Parkway Willoughby Hills, Ohio 44092 USA	Swagelok Company (Snow Metal) 6060 Cochran Road Solon, Ohio 44139 USA
Swagelok Company (Micro) 26653 Curtiss Wright Parkway Willoughby Hills, Ohio 44092 USA	Swagelok Company (Alfred) 29500 Ambina Drive Solon, Ohio 44139
Swagelok Hose Services Company (SHSC) 29900 Solon Industrial Parkway Solon, Ohio 44139	Swagelok Company (Strongsville) 15400 Foltz Road Strongsville, Ohio 44119
Swagelok (China) Fluid System Technologies Ltd. Changshu Export Process Zone Changshu Economic Development Zone Changshu, Jiangshu 215513 China	Swagelok Limited Ballafletcher Road Tromode IM4 4RA Isle of Man

